



Uptown Fire Pit Table

Installation Instructions for UPT-1242 and UPT-1242-BRN



Contents

Contents.....	2
Required Tools.....	3
Placing and assembling the Table.....	4
CF-SPARKER Installation.....	6
Gas Connections.....	6
Thermocouple Installation.....	8
Electrode Installation.....	8
Locating Propane tank.....	9
Locating Natural Gas Line.....	10
Fire Media Installation.....	11

Required Tools



- Utility Knife – ***To cut and remove packaging***



- 2 Open Ended Wrenches – ***To make gas connections***



- Phillips Screwdriver – ***To attach support base to top***



- Leather Gloves – ***To protect hands from rough edges found on the coffee table.***



- One (1) AAA Battery (not included) – ***Required for piezoelectric igniter installation.***



- Do not attempt to perform installation by yourself. This fire pit table is constructed of steel and heavy stone products. Have at least one other person help you.

Placing and Assembling the Fire Pit table

1. Remove all components from packaging.
2. Move the base sections to desired location and set into place spaced approximately 26.50" from each other.
3. When locating your coffee table, refer to the Crystal Fire® Plus manual and maintain clearance to combustibles.
4. Assemble in order as shown below.

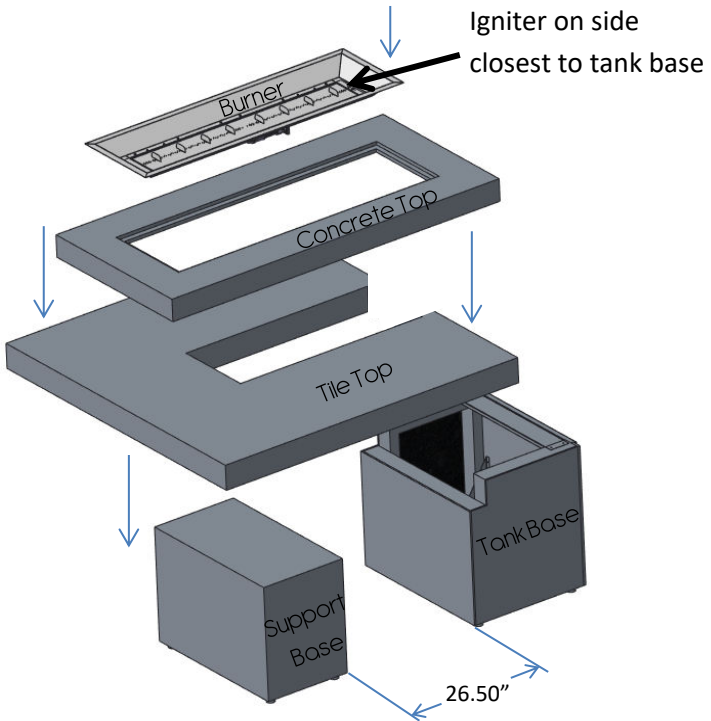

5. Insert supplied sheet metal screws into the locations shown by arrows below. This secures the tile top to the base.

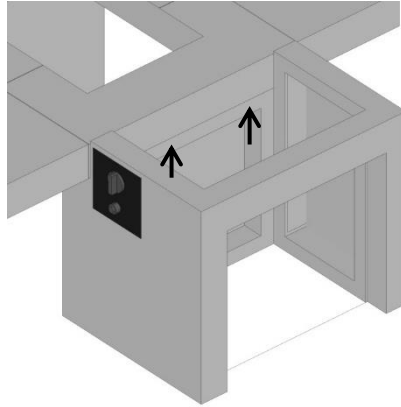

6. Align holes on support base with riv-nuts in the bottom of tile top. Using a Philips screwdriver and supplied bolts, attach the support base to the top as shown in the image below. Top may be needed to be lifted up to help position support base.

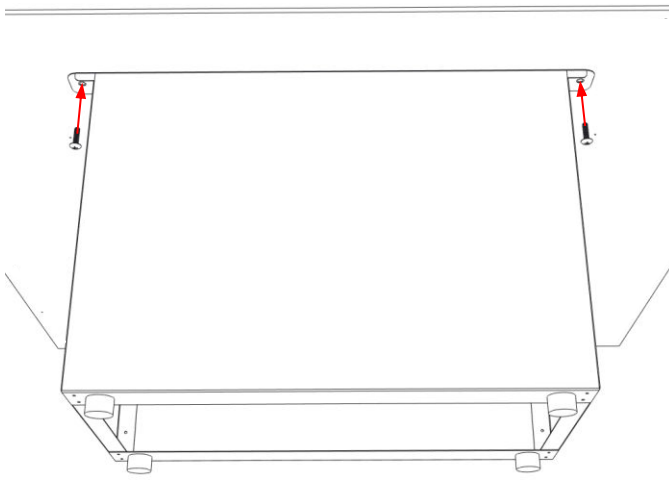

7. Align concrete top as shown by dashed line.



If the table is relocated, disconnect support base from tile top before moving. Failure to do so may result in riv-nuts becoming detached from tile top.

Read and understand your Crystal Fire® Plus owner's manual before beginning burner hookups or using the device.

CF-SPARKER Installation

- Locate CF-SPARKER inside of crystal fire burner box.
- Remove CF-SPARKER cap and hex nut. Insert AAA battery (not included) with + end out.
- Install CF-SPARKER into control panel as shown below.
- Depress CF-SPARKER button to test your sparker.

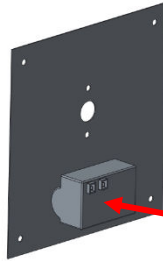
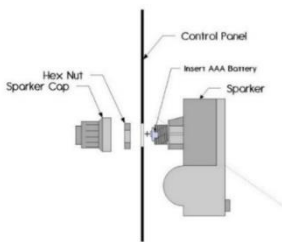

Locate and orient sparker box on control panel as shown. Sparker box must be installed **before** burner valve.

Gas Connections

Read and understand your Crystal Fire Burner Owner's manual before beginning burner hookups or using the device. Do not use Teflon tape or pipe dope on flare fittings.

- Using 2 wrenches, disconnect VCSV valve from flex line.

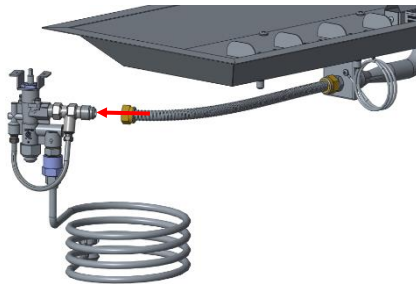

- **See Crystal Fire Plus instructions for burner installation.**

- All gas connections were completed at the factory.
- Check all connections for leaks. If needed, tighten connection with 2 wrenches and re-check for leaks.
- Attach burner valve to control panel with provided screws as shown below. Ensure spark box is installed before this step.

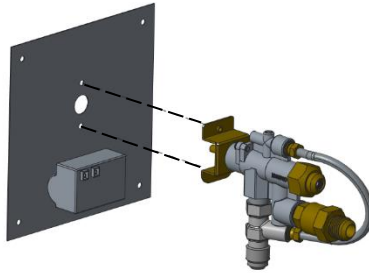

- Using 2 wrenches, reconnect VCSV valve to flex line.
Perform leak test on connection.

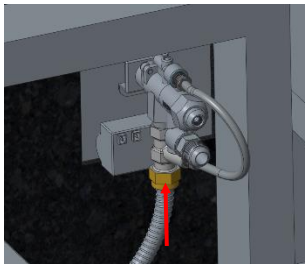

Thermocouple Installation

- Refer to Crystal Fire® Plus instruction manual for detailed attachment of thermocouple.
- Attach thermocouple to burner valve as shown below.

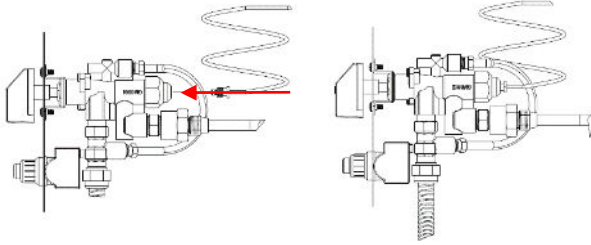

Electrode Installation

- Connect igniter and ground wire to sparker box. Both wires can connect to either connection point. The unit will operate in either configuration.
- Test system by pushing the button on the igniter. Consult the troubleshooting section of the Crystal Fire® Plus Burner Owner's Manual, if the spark is weak, intermittent, or not present.

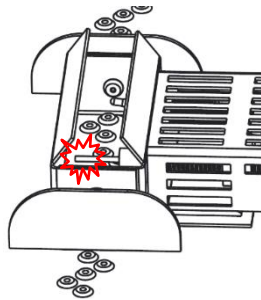
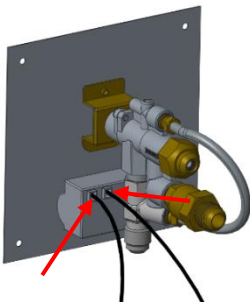

Locating your Tank

[If Applicable]

1. Tilt your propane tank into the slide out tank drawer.

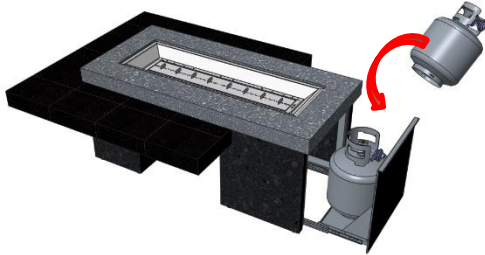

2. With the propane tank and control valve in the OFF position, connect the Regulator Hose, included with the Crystal Fire® Plus burner, to your propane tank (not included). Hand tighten connection, do not use tools to tighten this connection.

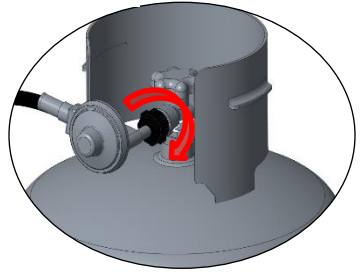

3. Slide tank drawer in. Ensure that the Gas hose does not get pinched in the process of sliding the tank drawer.



NOTE: Over time the bearings in the door glides may require re-greasing. Any spray lubricant, such as WD-40, may be used to lubricate drawer glides. Perform annually or on an as needed basis to maintain smooth operation.

Locating Natural Gas Line

(If Applicable)

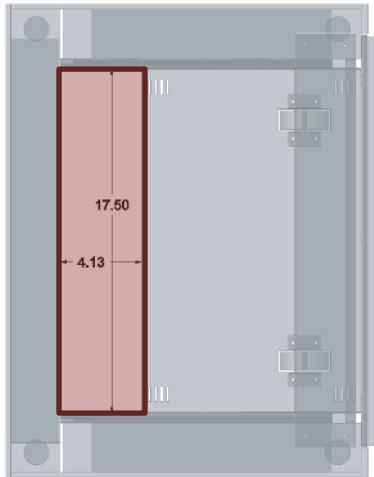

Top View of Base with Door

- Locate natural gas stub inside of the red outline to avoid clearance issues with the door for natural gas installations.

Fire Media Installation

- Scatter all included glass beads, lava rock, or other approved fire media evenly across entire burner surface.

**DO NOT BURN WITHOUT GLASS OR OTHER
APPROVED DECORATIVE FIRE MEDIA**

DO NOT BURN WITH GLASS COVER INSTALLED

IMPORTANT

Please consult your Crystal Fire® Plus instruction manual for detailed instructions and important information related to hooking up your linear burner, including safety information, proper tightening of connections with two wrenches and full burner setup and lighting instructions.

DO NOT ATTEMPT TO INSTALL CFP1242 BURNER WITHOUT FIRST CONSULTING THE MANUAL. IF YOU ARE UNSURE OF HOW TO COMPLETE THE STEPS OUTLINED, CONSULT A QUALIFIED TECHNICIAN

WARNING

After consulting the manual and following instructions, remember; before operating, all gas connections must be fully checked for leaks

 WARNING: This product can expose you to chemicals including Carbon Monoxide and Benzene which are known to the State of California to cause cancer or birth defects or reproductive harm. For more information, visit www.P65Warnings.ca.gov

Warranty: Fire pit tables are covered under a 1-year manufacturer's warranty. Please visit <https://www.outdoorrooms.com/product-registration> to register your product.

Thank you for purchasing an Outdoor GreatRoom Company product! This fire pit was made with pride in the USA.



9583 217th St. W. • Lakeville, MN 55044
Toll Free: 1-866-303-4028 • Sales@OutdoorRooms.com