

Homeowner's Installation Instructions & Operating Manual

ELECTRIC HEATER WITH REMOTE CONTROL
Model: GI-32-ZC
IS-36-ZC, IS-42-ZC Insert surrounds

READ AND SAVE THESE INSTRUCTIONS

READ CAREFULLY BEFORE ATTEMPTING TO ASSEMBLE, INSTALL, OPERATE OR MAINTAIN THIS PRODUCT.

PROTECT YOURSELF AND OTHERS BY OBSERVING ALL SAFETY INFORMATION. FAILURE TO COMPLY WITH INSTRUCTIONS COULD RESULT IN PERSONAL INJURY AND/OR PROPERTY DAMAGE.



WARNING! To reduce the risk of fire, electric shock, or personal injury, read all the instructions before using this heater.

IMPORTANT INSTRUCTIONS

When using electrical appliances, basic precautions should always be followed to reduce the risk of fire, electrical shock, and injury to persons including the following:

DANGER-High temperatures may be generated under certain abnormal conditions. Do not partially or fully cover or obstruct the front of the heater.

1. Read all instructions before using this appliance.
2. Do not use outdoors.
3. This appliance is not intended for use by children or others, unless they have been given supervision or instruction concerning use of the appliance by a person responsible for their safety.
4. Children should be supervised to ensure that they do not play with the appliance.
5. **This heater is hot when in use. To avoid burns, do not let bare skin touch hot surfaces.**
6. Extreme caution is necessary when any heater is used by or near children and whenever the heater is left operating unattended.
7. Unplug power cord before servicing or moving the heater. Always unplug heater when not in use.
8. Do not operate any heater with a damaged cord or after the heater malfunctions, has been dropped or damaged in any manner. Return heater to authorized service facility for examination, electrical or mechanical adjustment, or repair.
9. This heater is not intended for use in bathrooms, laundry areas and similar indoor locations. Never locate heater where it may fall into a bathtub or other water container.
10. Do not run cord under carpeting. Do not cover cord with throw rugs, runners, or the like. Arrange cord away from traffic area and where it will not be tripped over.
11. To disconnect heater, turn controls to off, then remove plug from outlet.
12. Connect to properly grounded outlets only.
13. Do not insert or allow fingers or foreign objects to enter any ventilation or exhaust opening as it may cause an electric shock or fire or damage the heater. Do not block or tamper with the heater in any manner while it is in operation.
14. To prevent a possible fire, do not block air intakes or exhaust in any manner. Do not use on soft surfaces, like a bed, where openings may become blocked.
15. A heater has hot and arcing or sparking parts inside. Do not use it in areas where gasoline, paint, or flammable liquids are used or stored.
16. Use this heater only as described in this manual. Any other use not recommended by the manufacturer may cause fire, electrical shock, or injury to persons.
17. Where possible, avoid the use of extension cords because the extension cord may overheat and cause a risk of fire.
18. This heater includes an overheat protection system that shuts off the heater when parts of the heater are getting excessively hot. If the heater shuts off, immediately turn the heater OFF and inspect for any objects, on or adjacent to the heater, which may cause high temperatures. **DO NOT OPERATE THE HEATER UNTIL IT IS RESET.** To reset the heater, turn it OFF, unplug it from the electrical outlet, and wait five to ten minutes for the unit to cool down before plugging it back in and turning the heater on.
19. Make certain that the power source conforms to the electrical requirements of the heater.
20. To prevent a possible fire, do not block air intakes or exhaust in any manner. Do not place heater on soft surfaces, like a bed, where openings may become blocked.
21. A heater has hot and arcing or sparking parts inside. It must NOT be used in potentially dangerous locations such as flammable, explosive, chemical-laden or wet atmosphere. This heater is intended for use in general use only.

WARNING: DO NOT DEPEND ON THE ON/OFF SWITCH AS THE SOLE MEANS OF DISCONNECTING POWER WHEN SERVICING OR MOVING THE HEATER. ALWAYS UNPLUG THE POWER CORD.

WARNING: REDUCE THE RISK OF FIRE OR ELECTRIC SHOCK---DO NOT USE THIS HEATER WITH ANY SOLID STATE SPEED CONTROL DEVICES.

22. SAVE THESE INSTRUCTIONS.

INSTALLATION INSTRUCTIONS

TOOL REQUIRED

Magnetic Phillips Screw Driver



Unpacking the Electric Fireplace



WARNING! Do NOT use this Electric Fireplace if any part has been under water. Immediately call a qualified service technician to inspect and to replace any part of the electrical system if necessary. Keep plastic wrapping away from children.

- Open the packaging carefully and remove the foam.
- Remove and discard the plastic bag.
- Be responsible when handling the packing materials.
- Keep the original packaging for future transport and/or storage.
- Check all accessories are got before you keep the packing.

PARTS AND HARDWARE LIST

remote control 1pc
 button cell battery 1pc
 instruction manual 1pc
 screw ST4x38 with nut 4pcs

PRODUCT SIZE

Fireplace insert for front fix	Insert Surround	Existing Fireplace

units: in

Model	Width (W)	Height (H)	Depth (D)	Fireplace opening size				Fireplace Minimum Depth (OD)
				Width (OW)		Height (OH)		
				Min	Max	Min	Max	
GI-32-ZC	31.4	20.6	8.7	29.1		19.7		8.5
IS-36-ZC	36.5	27	1	32	36	20	26.8	8.5
IS-42-ZC	42.5	28.5	1	32	42	20	28.4	8.5

LOCATING YOUR ELECTRIC FIREPLACE INSERT

Your new electric fireplace may be installed virtually anywhere in your home. The GI-29 was designed ideally for installation into existing fireplaces; however, when choosing a location ensure that the general instructions are followed. For best results, install out of direct sunlight. Power supply service must be either completed or placed within the electric fireplace prior to finishing to avoid reconstruction.

DANGER-High temperatures may be generated under certain abnormal conditions. Do not partially or fully cover or obstruct the front of the heater.

Clearance to Combustibles

Clearances to sides, floor, top and back: 0 in (0mm)

Before you begin: If a power outlet is not located inside the existing fireplace (always consult with local building codes before installing new outlets or modifying existing electrical systems) , the insert surround pictured below has two openings for the power cord to pass through if powering the unit from a nearby outlet outside the existing fireplace.

Be sure to plan for this if utilizing one of these pass-through holes.

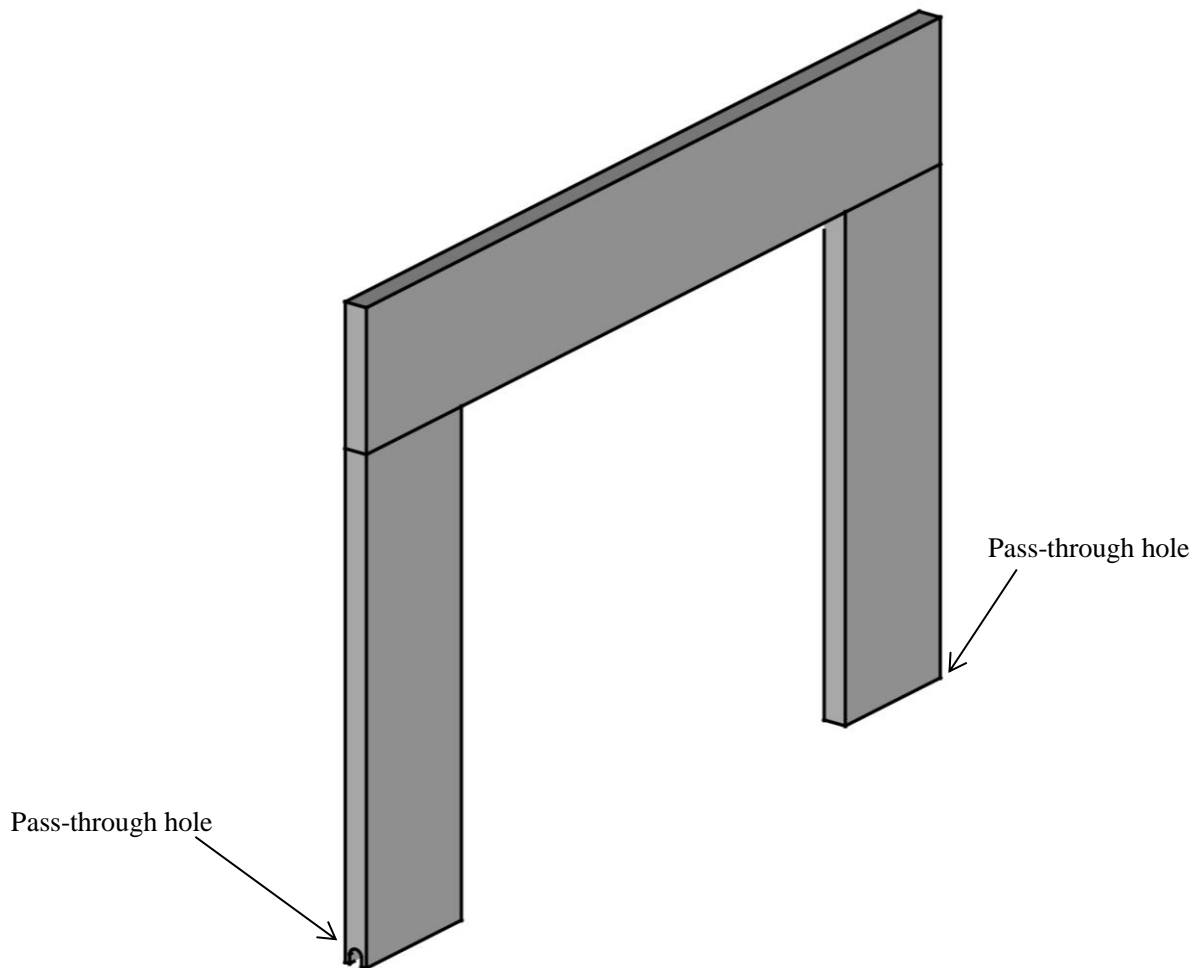

Note: The fireplace can be installed in one of two ways. Friction fit and permanent install. Choose whichever method works best for your application.

Begin by assembling the insert surround using the included screws and nuts in the orientation shown.

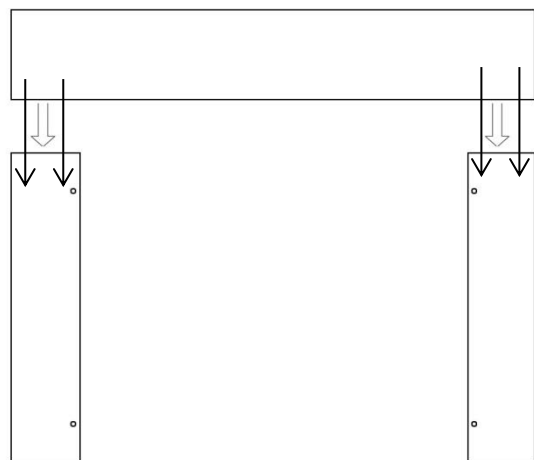

Method 1- Friction Fit

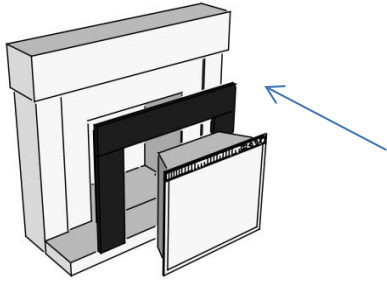

(1) Set Insert Surround into place, Slide in fireplace unit. Run electrical cord through pass-through hole if necessary

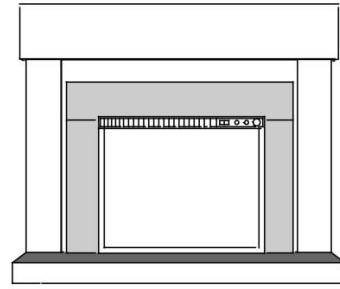

(2) Slide flush with front of fireplace

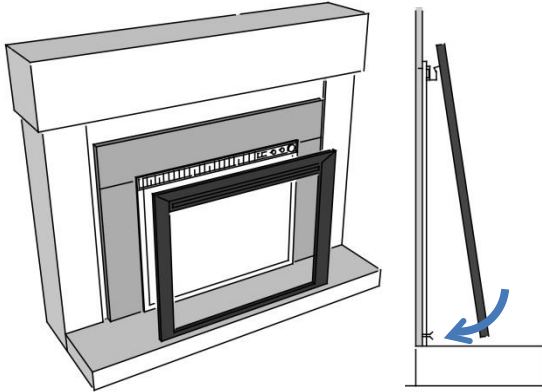

(3) Attach front face trim by hanging tabs on top, then pressing lower pins into spring clips at bottom.

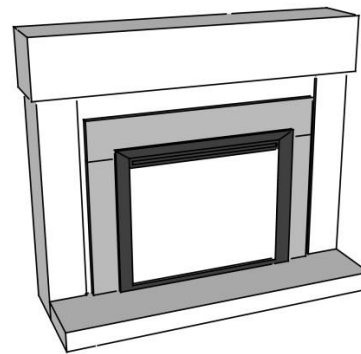

(4) Completed assembly

Method 2: Permanent Install

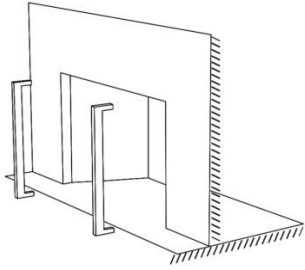

(1) Put 2 wood strips in existing fireplace cut to fit the height of the opening, and spaced 26.5" apart

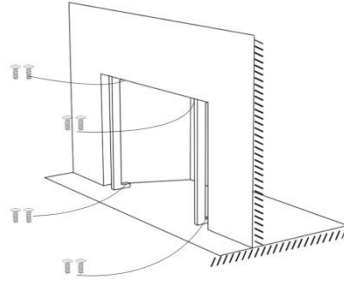

(2) Fix the wood strips with masonry screws or other appropriate screws for the material you're attaching to.

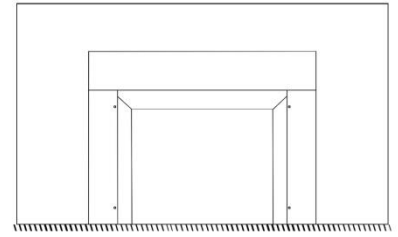

(3) set insert surround into place. Run cord through passthrough hole if necessary .

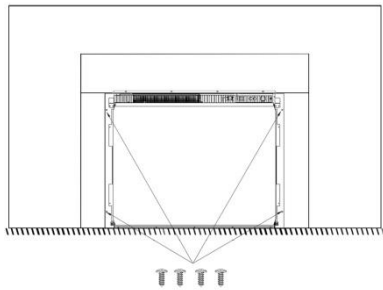

(4) Put the fireplace insert into place and using wood screws (not included) attach the insert to the surround and wood strips at shown locations.

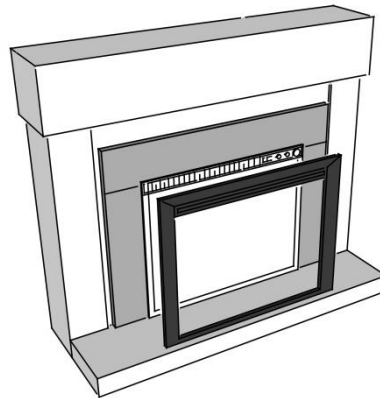

(5) Attach front face trim by hanging tabs on top, then pressing lower pins into spring clips at bottom

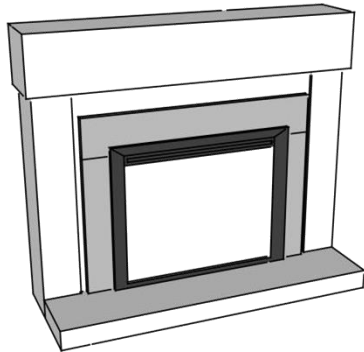
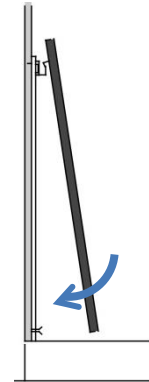

(6) Completed Assembly

GROUNDING

Plug the power supply cord into a wall outlet (120Vac, 60Hz). The cord has a plug as shown at A. You should follow as shown at the below:

Grounding methods

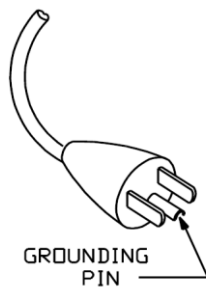

GROUNDING
PIN

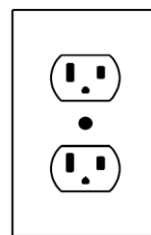

(A)

ELECTRICAL CONNECTION

A 15 AMP, 120 Volt, The unit comes standard with 6 feet (1.8 m) three wire cord, exiting from the rear of the fireplace. Plan the installation to avoid the use of an extension cord. Preferably, the fireplace will be on a dedicated circuit as other appliances on the same circuit may cause the circuit breaker to trip or the fuse to blow when the heater is in operation.

OPERATING INSTRUCTIONS

This appliance can be operated by both remote control and manual button controls on the fireplace. Once the unit has been properly connected to a grounded electrical outlet, turn on the main power switch located on the left hand side of the appliance. A beep should be heard when the power is first applied.



CAUTION! The unit's power cord must be connected to a properly grounded and protected 120V outlet. Always use ground fault protection where required by the electrical code.



WARNING! Do not operate the unit if it is damaged or has malfunctioned. If you suspect the unit is damaged, please call a qualified service technician to inspect and to replace any part of the electrical system if necessary.

NOTE! To use both remote and manual functions, the main power switch must be in "ON" position.

● Operating by Manual Button

NOTE! The manual button on the fireplace unit does not provide you with all function control, and it's purpose is to control some basic function in the event you lose the remote handset. Please use the remote handset to carry out all functions.

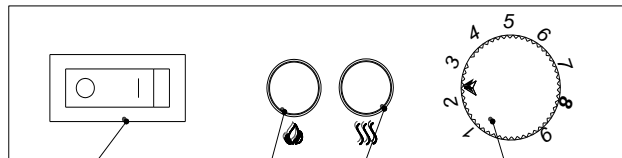

Main power switch Flame button Heater button Thermostat knob

NOTE: The lights will always be on when the appliance is on.

Main power switch

The POWER switch supplies power to all of the functions of the fireplace. This switch must be in the "ON" position for any of the functions including the remote to work.

Flame button

By pressing the FLAME button, the unit will cycle through five flame effects. If you need more flame, please use the remote handset.

Heater button

Press to turn on low heat setting. (Pilot lights illuminated ●○).

Press again for high heat setting. (Pilot lights illuminated ●●)

Press a third time to turn heat off completely. (Pilot lights illuminated ○○).

There are 3 levels you can cycle through including the OFF setting.

Thermostat control

Your unit contains a 9 Step thermostat-controlled heater ranging from 32-93 degrees F. If room temperature is too high, turn the thermostat knob counter-clockwise direction; If you need to turn on the heater, you can turn the thermostat knob clockwise.

To Reset the Heater

Your heater includes a protection system that shuts off the heater if it overheats for any reason:

- 1) Turn unit to the OFF position.
- 2) Unplug unit and wait 5 minutes.
- 3) Plug in again and turn on.

● Remote control functions

Note: The fireplace Main Power Switch must be switched ON in order for the Remote Control to function.

Note:

If all light features are turned off and heater is turned on, the heater indicator light will remain lit. If other light effects are turned on, the heater indicator light will turn off after a short period of time.

In order to protect the product from overheating, there is an 8 second delay when turning on the heater; also there is 8s delay when turning off the heater fan.

	SYMBOL	TITLE	FUNCTION
		POWER	The Power button will put the fireplace in a standby mode. This will turn off all functions at once but will hold the settings in memory. Except Heater function, by pressing the button again the unit will turn on at the same settings.
		FLAME	By pressing the FLAME button, the unit will cycle through four flame effects.
		EMBER BED	By pressing the EMBER BED button, the unit will cycle through five flame effects.
		DOWN LIGHT	By pressing the downlight button the unit will cycle through two effects including OFF and ON setting.
	HEATER	Press once for low heater setting (Pilot lights illuminated ●○). Press again for high setting. (Pilot lights illuminated ●●) Pressing a third time turns heat off. (Pilot lights illuminated ○○).	

NOTE: This remote control uses 1 CR2032 Lithium Ion button cell battery (Included). Never dispose of batteries in fire, except under conditions of controlled incineration. (Failure to observe this precaution may result in an explosion.)

NOTE: This equipment has been tested and found to comply with the limits for Class B digital device, pursuant to part 15 of the FCC Rules. These limits are designed to provide reasonable protection against

harmful interference in a residential installation. This equipment generates, uses, and can radiate radio frequency energy and, if not installed and used in accordance with the instructions, may cause harmful interference to radio or television reception, which can be determined by turning the equipment off and on,

the user is encouraged to try to correct the interference by one or more of the following measures:

- Reorient or relocate the receiving antenna.

- Increase the separation between the equipment and the receiver.
- Connect the equipment into an outlet on a circuit different from that to which the receiver is connected.
- Consult the dealer or an experienced radio/TV technician for help.

This device complies with Part 15 of the FCC Rules. Operation is subject to the following two conditions:

- (1) This device may not cause harmful interference, and
- (2) this device must accept any interference received, including interference that may cause undesired operation.

Modifications not approved by the party responsible for compliance could void user's authority to operate the equipment.

This Class B digital apparatus complies with Canadian ICES-003.

MAINTENANCE

WARNING: ALWAYS UNPLUG THE CORD BEFORE MOVING OR SERVICING. DO NOT IMMERSER HEATER IN WATER!

- Always turn OFF the heater and disconnect the cord from the electrical outlet before cleaning your heater.
- Light accumulated dust may be removed from the heater with a soft cloth or vacuum cleaner.
- Wipe the exterior surfaces of the heater occasionally with a slightly damp cloth (not dripping wet) using a solution of mild detergent and water. Dry the case thoroughly before operating the heater.

Caution: Do not allow water to run into the interior of the heater as this could create a fire or electric shock hazard.

- The fan motor is factory lubricated for life and will not require further lubrication.
- Store heater in a clean dry place when not in use.

Warning: Any other servicing needed must be performed by an authorized service representative. Do not attempt to service the unit yourself.

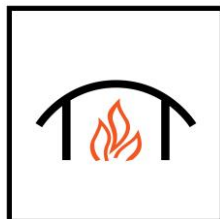
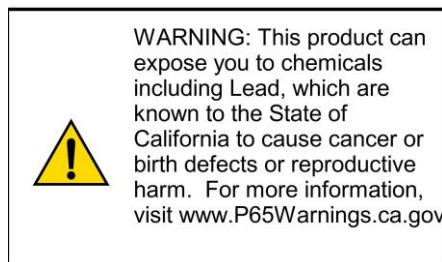

14400 Southcross Drive West • Suite 100 • Burnsville, MN 55306
Toll Free: 1-866-303-4028 • Sales@OutdoorRooms.com