

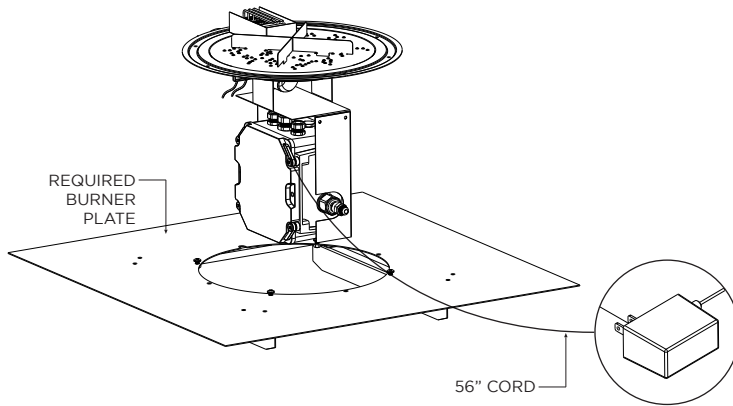

BP30SDSI(LP/NG)-A Kit

Direct Spark Ignition (DSI)



ISOMETRIC VIEW

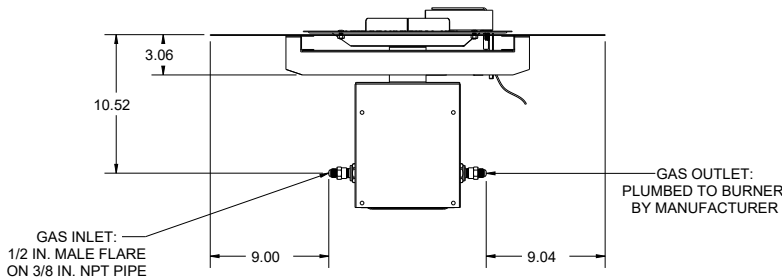
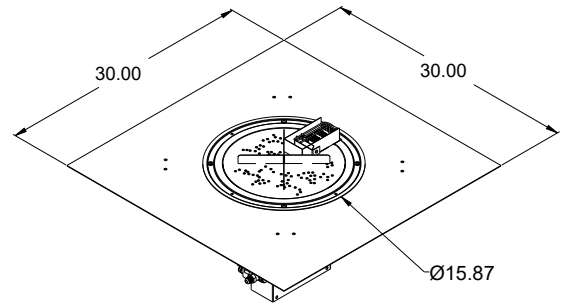

FRONT ELEVATION

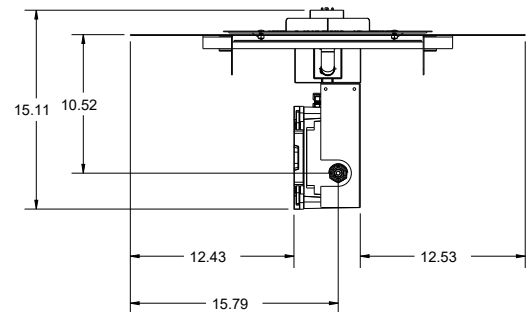

SIDE ELEVATION

Specifications:

KIT NAME	KIT WEIGHT	BTUs (LP/NG)	FIRE MEDIA	CUSTOM SIZE PLATES AVAILABLE - CONTACT OGC FOR QUOTE
BP30SDSI(LP/NG)-A	35.2 LBS	55K*	45 LBS	

*BOOSTER ORIFICE AVAILABLE TO INCREASE BTU CAPACITY IF DESIRED AND APPROVED FOR FINISHING STRUCTURE
TESTING AGENCY: UNDERWRITERS LABORATORIES (UL LLC)
STANDARD: ANSI Z21.97-02017 / CSA 2.41-2017 OUTDOOR DECORATIVE GAS APPLIANCES

Notes:

- ENCLOSURES
 - Recommend 2 ea 10 sq in. vents on opposing sides.
- CLEARANCE TO COMBUSTIBLES
 - 72" from top of burner to any overhead combustible material. 24" from edge of burner trim to any combustible side walls. 4" from bottom of burner to combustible materials.
- GAS SUPPLY
 - Natural gas - Operating Supply Pressure: Min 6" W.C.; Max 10.5" W.C.; Ideal 7" W.C.
 - Liquid Propane gas - Operating Supply Pressure: Min 8" W.C.; Max 14" W.C.; Ideal 11" W.C.
- ELECTRICAL
 - RECOMMENDED: A readily accessible outlet on GFCI circuit should be installed within the enclosure to local electrical code. A weather proof cover (PT# CF-DSI-JB or equivalent) should be used. Must follow required local electrical code.
 - ALTERNATIVE: Unit can be powered with a 2D cell battery pack (PT# CF-DSI-BP). Pack should be located in a dry, **accessible** area of fire pit. Battery pack must be easy to access after installation is complete.
- CONTROLS
 - Controls located on the Appliance Structure: Low voltage switch comes standard with DSI Burners. Optional 60-Minute Timer (PT# CF-DSI-60MT) can replace low voltage switch.
 - Controls located away from the Appliance Structure: Outdoor-rated switches and timers (PT# CF-DSI-60MT) can be located on GFCI Circuit to control power to the junction box. **Note:** If operating burner with switch away from the appliance, the low voltage switch must be set to the ON position. Another option is to bypass the switch with PT# CF-DSI-SB.
 - Emergency Gas Shut Off: The E-Stop ships standard with the Direct Spark Ignition (DSI) burner and can be installed on the GFCI circuit to cut power to the appliance's junction box which will shut off flame.