

LEGACY CONVECTION RANGE



OPERATING AND ASSEMBLY INSTRUCTIONS

Models: LG24i
LG36i (shown)

GAS-FIRED

LISTED

CAUTION



DO NOT DISCARD THIS MANUAL

- Important operating and maintenance instructions included.
- Read, understand and follow these instructions for safe installation and operation.
- Leave this manual with party responsible for use and operation.



⚠ WARNING: If the information in these instructions is not followed exactly, a fire or explosion may result causing property damage, personal injury or death.

FOR YOUR SAFETY

Do not store or use gasoline or other flammable vapors and liquids in the vicinity of this or any other appliance. An LP cylinder not connected for use shall not be stored in the vicinity of this or any other appliance.

FOR YOUR SAFETY

If you smell gas:

- Shut off gas to the appliance.
- Extinguish any open flame.
- Open lid.
- If odor continues, immediately call your gas supplier or your fire department.

Read the following instructions carefully and be sure your grill is properly installed, assembled and maintained.

Failure to follow these instructions may result in serious bodily injury and/or property damage. If you have questions concerning assembly or operation, consult your dealer, gas appliance service person or your LP gas company.

This outdoor cooking gas appliance is not intended to be installed in or on recreational vehicles and/or boats.

Installation and service must be performed by a qualified installer, service agency, or the gas supplier. In the Commonwealth of Massachusetts installation must be performed by a licensed plumber or gas fitter.

TABLE OF CONTENTS

WARRANTY	3
SAFETY INSTRUCTIONS	4
SERVICE PARTS LIST	6
CONNECTING GAS CYLINDER	10
LIGHTING AND OPERATING INSTRUCTIONS	11
COOKING INSTRUCTIONS	13
CLEANING AND MAINTENANCE INSTRUCTIONS	14
CONTACT INFORMATION	16

WARRANTY



Legacy-24i/36i Gas Grills Limited Lifetime Warranty

Fire Stone extends the following warranty for Legacy-24i/36i Gas Grills used in the United States of America or Canada. Dealers and employees of Fire Stone have no authority to make any warranty or authorize any remedies in addition to or inconsistent with the terms of this warranty. This warranty gives you specific legal rights. You may also have other rights that vary from state to state.

Fire Stone warrants that this Legacy-24i/36i Gas Grill (the "Product") will be free from defects in material and workmanship as follows:

- Stainless steel parts - for the life of the Product.
- All other parts - for a period of one year from the Product's date of purchase.

This warranty is subject to the conditions, exclusions and limitations described below.

This warranty applies only to the original owner of the Product and is nontransferable. Fire Stone's obligation under this warranty does not extend to damages resulting from (1) assembly, operation or maintenance of the Product not in accordance with the Installation/Assembly Instructions, Operating Instructions and the Listing Agency Identification Label furnished with the Product; (2) installation or use which does not comply with local building codes and ordinances; (3) shipping, improper handling, improper operation, abuse, misuse, accident or unworkmanlike repairs; (4) use of fuels other than those specified in the Operating Instructions; (5) installation or use of components not supplied with the Product or any other components not expressly authorized and approved in writing by Fire Stone; and/or (6) modification of the Product not expressly authorized and approved in writing by Fire Stone. Any of the circumstances described in the previous sentence voids this warranty. This warranty is void if the Product or any component has been removed, repaired or replaced before Fire Stone has been afforded a reasonable opportunity to inspect the Product. This warranty does not cover LP tanks.



This warranty is limited to the replacement of defective components and Fire Stone may fully discharge its obligations under this warranty by replacing, at its discretion, the defective components. Fire Stone will provide replacement parts at no charge and will pay reasonable and necessary freight costs related to replacing defective components under this warranty. The maximum amount recoverable under this warranty is limited to the purchase price of the Product and, if Fire Stone is unable to provide replacement components in an expedient and cost-effective manner, Fire Stone may discharge all obligations under this warranty by refunding the purchase price of the Product.

EXCEPT TO THE EXTENT PROVIDED BY LAW, FIRE STONE MAKES NO EXPRESS WARRANTIES OTHER THAN THE WARRANTY EXPRESSED HEREIN. THE DURATION OF ANY IMPLIED WARRANTY IS LIMITED TO THE DURATION OF THE WARRANTY SPECIFIED ABOVE. IN NO EVENT SHALL FIRE STONE BE LIABLE FOR ANY INCIDENTAL OR CONSEQUENTIAL DAMAGES CAUSED BY DEFECTS IN THE PRODUCT. Some states do not allow limitations on how long an implied warranty lasts, or do not allow exclusion or limitation of incidental or consequential damages, so these limitations may not apply to you.

To obtain service under this warranty, you must:

1. Obtain service and/or parts at any authorized dealer, or send written notice of the claimed condition to Fire Stone Home Products, 12400 Portland Ave. So., Burnsville, MN 55337.
2. Provide documentary proof that you are the original owner of the Product.
3. Provide Fire Stone reasonable opportunity to investigate the claim, including reasonable opportunity to inspect the Product prior to any repair or replacement work and before the Product or any component of the Product has been removed.

Read These Safety Instructions

	WARNING	
	Fire Risk	
	Explosion Risk	
Failure to comply with these instructions could result in a fire or explosion which could cause property damage, serious bodily injury or death.		

	WARNING
Combustion by-products produced when using this product contain chemicals known to the State of California to cause cancer, birth defects, or other reproductive harm.	

Grill Installation Codes

This grill has been tested in accordance with ANSI Z21.581995/CGA 1.6-M95 and Z21.58a-1998/CGA1.6a-M98. This gas grill must be installed in accordance with all local codes. In areas without local codes, follow the latest edition of the National Fuel Gas Code ANSI Z223.1. In Canada, installation must conform to standard CAN/CGA B149.1 (Natural Gas Installation Code) or B149.2 (Propane Installation Code) and all local codes.

Proper Placement and Clearance of Grill

Never use this gas grill in a garage, porch, shed, breezeway or any other enclosed area. The gas grill is to be used outdoors only, with at least 6" clearance from the back and side of the grill to any combustible surface. The gas grill shall not be located under overhead unprotected combustible construction. Do not obstruct the flow of combustion or ventilation air around the gas grill housing.

This outdoor gas grill is not intended to be installed in or on recreational vehicles and/or boats. If installed other than in the grill cart, refer to ANSI Z223.1 for specific details relative to installation within a confined space.

Correct LPG Cylinder Use



This gas grill is designed for use with a standard 20 lb. Liquid Propane Gas (LPG) cylinder, not included with grill box. Never connect the gas grill to an LPG cylinder that exceeds this capacity. A cylinder of approximately 12 inches in diameter by 18-1/2 inches high should be the maximum size LPG cylinder used. We recommend buying an "OPD" gas cylinder which offers an Overfill Prevention Device. This safety feature prevents the cylinder from being overfilled which can cause malfunction of the LPG cylinder, regulator and/or grill.

The LPG cylinder must be constructed and marked in accordance with the Specifications for LP-Gas Cylinders of the U.S. Department of Transportation (DOT) or the National Standard of Canada, CAN/CSA-B339, Cylinders, Spheres and Tubes for Transportation of Dangerous Goods: and Commission, as applicable.

In addition:

1. The LPG cylinder must also be provided with a listed overfilling prevention device, and a cylinder connection device compatible with the connection for outdoor cooking appliances.
 2. The cylinder supply system must be arranged for vapor withdrawal.
 3. The LPG cylinder used must have a collar to protect the cylinder valve.
- Never connect an unregulated LPG cylinder to the gas grill. The gas regulator assembly supplied with this gas grill is adjusted to have an outlet pressure of 11" water column (W.C.) for connection to an LPG cylinder.
 - Only use the regulator and hose assembly supplied with the gas grill. Replacement pressure regulators and hose assemblies must be those specified by Fire Stone.
 - Have the LPG cylinder filled by a reputable propane gas dealer and visually inspected and re-qualified at each filling.
 - Never fill the gas cylinder beyond 80% full. Have the propane gas dealer check the release valve after every filling to ensure that it remains free of defects.
 - Always keep LPG cylinders in an upright position.
 - Keep the ventilation openings of the cylinder enclosure free and clear from debris.
 - Do not store (or use) combustible materials, gasoline or other flammable vapors and liquids in the vicinity of this gas grill.
 - An LPG cylinder that is not connected for use must not be stored in the vicinity of this or any other gas grill.
 - Do not subject the LPG cylinder to excessive heat.
 - Never store an LPG cylinder indoors. If storing the gas grill in the garage or other indoor location, always disconnect the LPG cylinder first and store it safely outside in a well-ventilated area.
 - When the gas grill is not in use the gas must be turned off at the LPG cylinder.
 - The regulator and hose assembly must be inspected before each use of the grill. If there is excessive abrasion or wear or if the hose is cut, it must be replaced prior to the grill being used again.

- If the hose appears damaged do not use gas grill. Call your dealer for a factory authorized replacement hose.
- Keep the gas regulator hose away from hot grill surfaces and dripping grease. Avoid unnecessary twisting of hose. Visually inspect hose prior to each use for cuts, cracks, excessive wear or other damage.
- **Never** light the gas grill with the lid closed or before checking to insure the burner tubes are fully seated over the gas valve orifices.
- **Never** allow children to operate the grill. Do not allow children to play near the grill.

	⚠ WARNING	
	Fire Risk Explosion Risk	
<p>A strong gas smell, or the hissing sound of gas indicates a serious problem with the gas grill or the LPG cylinder.</p> <ul style="list-style-type: none"> • Get away from the LPG cylinder. • Do not try to fix the problem yourself. • Call the fire department. (Do not call near the LPG cylinder because the telephone is an electrical device.) <p>Failure to immediately follow the steps listed above could result in a fire or explosion which could cause property damage, serious bodily injury or death.</p>		

Beware of Spiders

CAUTION: Spiders and small insects occasionally spin webs or make nests in the grill burner tubes during transit and warehousing. These webs can lead to a gas flow obstruction which could result in a fire in and around the burner tubes. This type of fire is known as a “FLASH-BACK” and can cause serious damage to the grill and create an unsafe operating condition for the user.



Although an obstructed burner tube is not the only cause of “FLASH-BACK”, it is the most common cause.

To reduce the chance of “FLASH-BACK”, clean the burner tubes before assembling the grill, and at least once a month in late summer or early fall when spiders are most active. Also perform this burner tube cleaning procedure if the grill has not been used for an extended period of time.

Safety Instructions

Natural Gas Safety (Conversion Kit available through Fire Stone)



This converted natural gas grill is designed to operate on natural gas ONLY, at a pressure of 7” water column (W.C.) (1/4 psig or 1.75 kpa), regulated at the residential meter. Check with the gas utility for local gas pressure and with the local municipality for building code requirements. If the residential gas utility line pressure has not been regulated to 7” W.C., contact the local gas utility or gas grill dealer for professional assistance.

Check with the gas utility or with local building codes for instructions to install gas supply line, or call a licensed and knowledgeable installer. The grill must be chained to stay in one location so that it cannot roll.

It is recommended that an “ON-OFF” shut-off valve be installed at the gas supply source:

- outdoors after gas line piping exits outside wall and before quick-disconnect, or before gas line piping enters ground.
- indoors in the branch fuel line in an accessible location near the supply line.

Converting to Natural Gas

	⚠ WARNING	
	Fire Risk Explosion Risk	
<p>Only factory authorized dealers may convert the grill from LP to NG.</p> <ul style="list-style-type: none"> • Any attempt to do otherwise voids the product warranty and releases Fire Stone from all liabilities due to unauthorized conversion. • Failure to comply with these instructions could result in fire or explosion which could cause property damage, serious bodily injury, or death. 		

Pipe sealing compound or pipe thread tape of the type resistant to the action of natural gas must be used on all male pipe threads when making the connection.

Disconnect the gas grill from fuel source when the gas supply is being tested at high pressures. This appliance and its individual shut-off valve must be disconnected from the gas supply piping system during any pressure testing of that system at pressure in excess of 1/2 psi (3.5kpa).

Turn off the gas grill when the gas supply is being tested at low pressures. This appliance must be isolated from the gas supply piping system by closing its individual manual shut-off valve during any pressure testing of the gas supply piping system at pressures equal to or less than 1/2 psi (3.5kpa).



Service Parts

LG24i

(NG, LP) Exploded Parts Diagram

Beginning Manufacturing Date: 5-04
Ending Manufacturing Date: _____

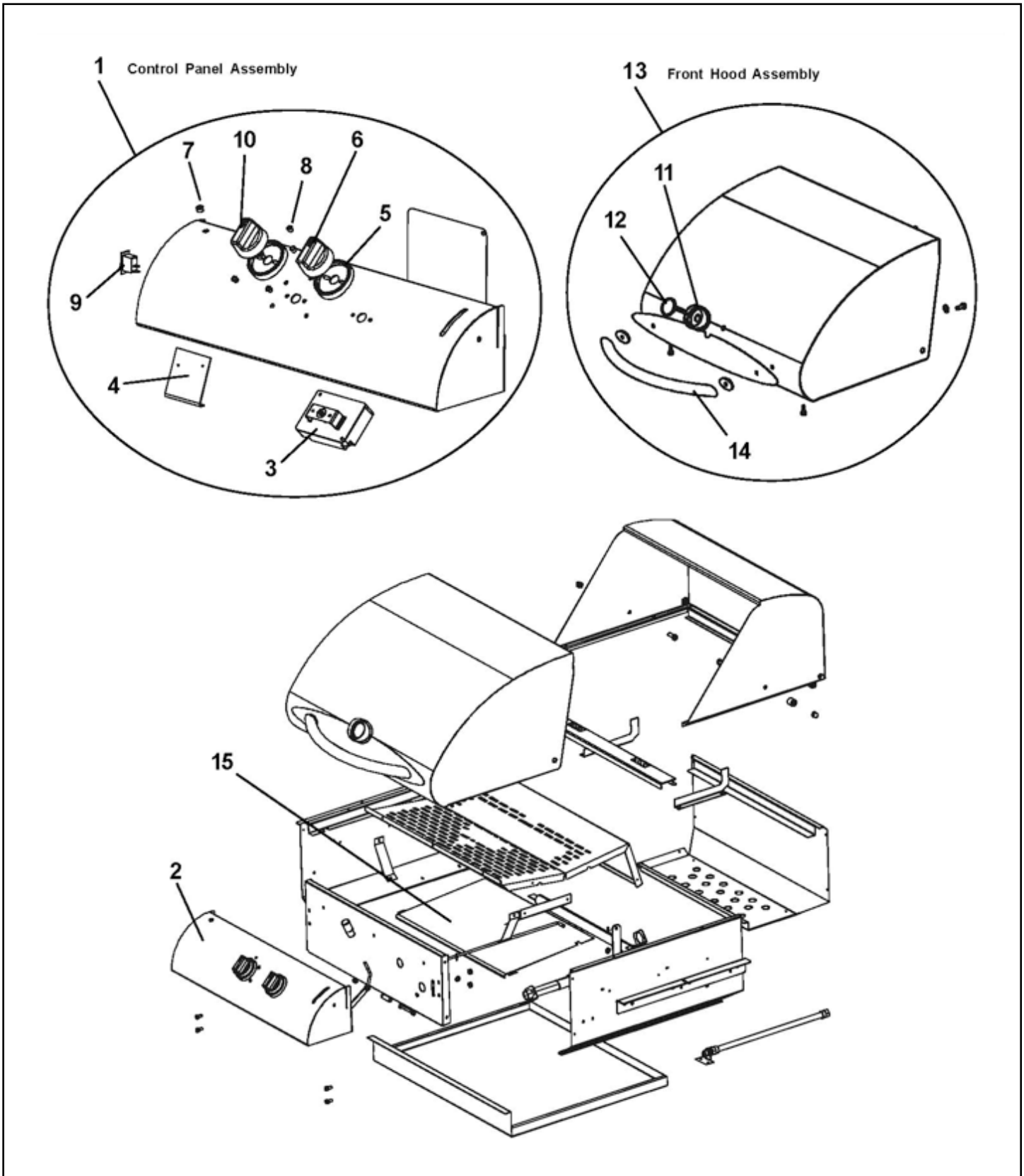

Remove all components from the packing carton and place within easy reach. Do not throw the shipping carton away; instead use it as an elevated assembly surface.

How to Order Replacement Parts

LG24i Service Parts List

IMPORTANT: THIS IS DATED INFORMATION. The most current information is located on your dealers VIP site. When ordering, supply serial and model numbers to ensure correct service parts.

ITEM	DESCRIPTION	PART NUMBER
1	24 in. Control Panel Assembly	JL24-761-107A-L
2	24 in. Control Panel	JL24-761-111
3	Logic Box Assembly	JL-760-189A
4	Battery Pack Mount	JL-760-209
5	Bezel	JL-760-145
6	Control Knob - "D" Shaft	JL-760-188A
7	Snap Bushing	760-207
8	Snap Bushing	JL-760-208
9	Rocker Switch On/Off	230-0730
10	Control Knob - Spline Shaft	JL-760-195A
11	Temp Gauge Cover	JL-760-187
12	Temp Gauge	JL-760-183A
13	24 in. Front Hood Assembly	JL24-761-116A
14	Handle	JL-761-126A
15	24 in. Vaporizer Plate	JL24-761-200A
Items not shown		
	Battery Pack	593-594A
	24 in. Valve	760-191
	24 in. Wire Harness	JL-24-760-193
	Probe	760-144
	Searing Plate	760-108
	SS Grill	760-109
	Hose and Regulator	760-182
	Ignitor	JL-761-303
	Ignition Wire	JL-761-304

To order replacement parts, contact the dealer where the product was purchased.

To obtain the correct replacement part(s) for this Patio Gourmet Series III gas grill, please refer to the service parts list. The following information is required to assure receipt of correct parts:

- Gas Grill Model Number (see data sticker on grill)
- Part Number AND Part Description
- Quantity of parts needed

Important: Keep this assembly and operating instruction manual for convenient referral and for part replacement.

Important: Use only factory authorized parts. The use of any unauthorized factory part can be dangerous and will also void the product warranty.



**FIRE
STONE**

Service Parts

(NG, LP) Exploded Parts Diagram

LG36i

Beginning Manufacturing Date: 5-04

Ending Manufacturing Date: _____

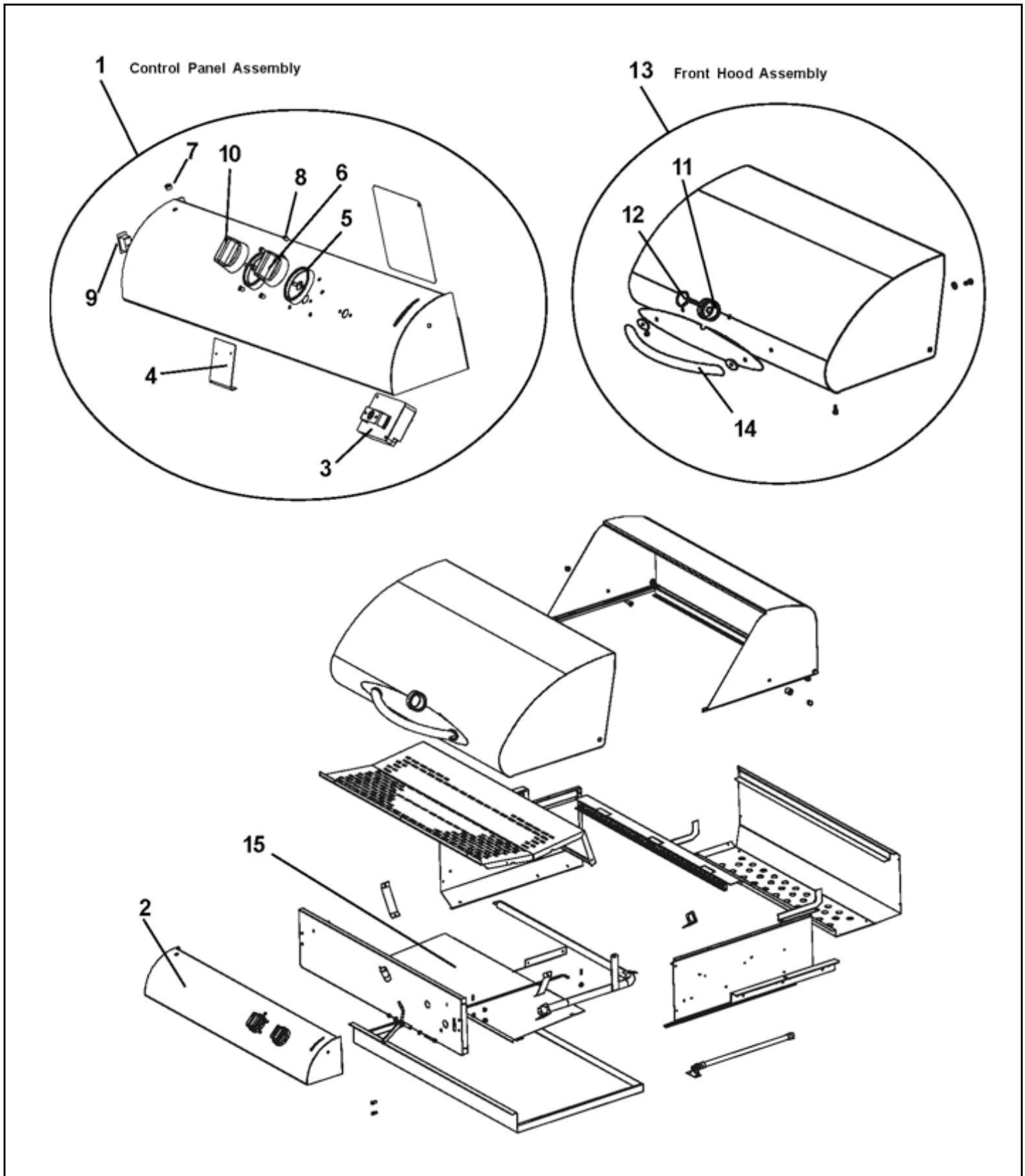

Remove all components from the packing carton and place within easy reach. Do not throw the shipping carton away; instead use it as an elevated assembly surface.

How to Order Replacement Parts

LG36i Service Parts List

IMPORTANT: THIS IS DATED INFORMATION. The most current information is located on your dealers VIP site. When ordering, supply serial and model numbers to ensure correct service parts.

ITEM	DESCRIPTION	PART NUMBER
1	36 in. Control Panel Assembly	JL-761-107A-L
2	36 in. Control Panel	JL-761-111
3	Logic Box Assembly	JL-760-189A
4	Battery Pack Mount	JL-760-209
5	Bezel	JL-760-145
6	Control Knob - "D" Shaft	JL-760-188A
7	Snap Bushing	760-207
8	Snap Bushing	JL-760-208
9	Rocker Switch On/Off	230-0730
10	Control Knob - Spline Shaft	JL-760-195A
11	Temp Gauge Cover	JL-760-187
12	Temp Gauge	JL-760-183A
13	36 in. Front Hood Assembly	JL-761-116A
14	Handle	JL-761-126A
15	36 in. Vaporizer Plate	JL-761-200A
Items not shown		
	Battery Pack	593-594A
	36 in. Valve	761-191
	36 in. Wire Harness	JL-760-193
	Probe	760-144
	Searing Plate	760-108
	SS Grill	760-109
	Hose and Regulator	760-182
	Ignitor	JL-761-303
	Ignition Wire	JL-761-304

To order replacement parts, contact the dealer where the product was purchased.

To obtain the correct replacement part(s) for this Patio Gourmet Series III gas grill, please refer to the service parts list. The following information is required to assure receipt of correct parts:

- Gas Grill Model Number (see data sticker on grill)
- Part Number AND Part Description
- Quantity of parts needed

Important: Keep this assembly and operating instruction manual for convenient referral and for part replacement.

Important: Use only factory authorized parts. The use of any unauthorized factory part can be dangerous and will also void the product warranty.

Connecting Gas Cylinder

Connecting A Liquid Propane Gas (LPG) Cylinder To The Grill

1. Place the fixed gas cylinder in the designated hole in the bottom of the cart. Attach tank clamp to cylinder and cart using wing nut (supplied with the cart). Make sure the LPG cylinder valve is in the full OFF position. (Turn clockwise to close.)
2. Check the cylinder valve features to ensure it has proper external mating threads to fit the hose and regulator assembly provided. (Type 1 connection per ANSI Z21.58a-1998)
3. Make sure the burner valve is in the OFF position.
4. Inspect the valve connection port and regulator assembly. Look for any damage or debris. Remove any debris. Inspect hose for damage. Never attempt to use damaged or plugged equipment.
5. Connect brass fitting on the end of the hose/regulator assembly to valve of grill (remove red cap from valve).
6. When connecting the hose and regulator assembly to the cylinder valve, hand tighten nut clockwise to a full stop (see Figure 1). DO NOT use a wrench to tighten because it could damage the Quick Coupling Nut and result in a hazardous condition.
7. Open the cylinder valve fully (counterclockwise). Use a commercially-available, non-corrosive leak check solution to check all connections for leaks before attempting to light the grill. If a leak is found, turn the cylinder valve off and do not use the grill until repairs are made.

Disconnecting A Liquid Propane Gas (LPG) Cylinder From The Grill

1. Turn the burner valves and LPG cylinder valve to the full OFF position. (Turn clockwise to close.)
2. Detach the hose and regulator assembly from the LPG cylinder valve by turning the Quick Coupling Nut counterclockwise.

CAUTION: When the appliance is not in use, the gas must be turned off at the supply cylinder.

Congratulations

Your Legacy-24i/36i gas grill is now ready for use. Before the first use and at the beginning of each season (and whenever the LPG gas cylinder has been changed):

1. Read all safety, lighting and operating instructions.
2. Check gas valve orifices, burner tubes and burner ports for any obstructions.
3. Perform gas leak check according to instructions found in this manual.

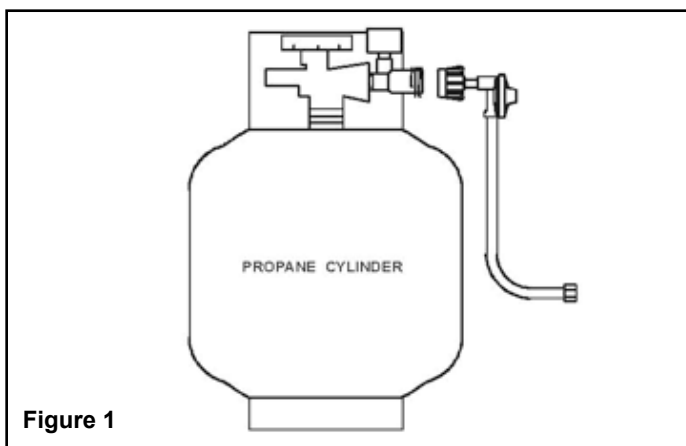



Figure 1

Lighting Instructions

Basic Lighting Procedures



1. Familiarize yourself with the safety guidelines at the front of this manual. Do not smoke while lighting grill or checking gas supply connections.
2. Be sure the LPG cylinder is filled.
3. Make sure all gas connections are securely tightened.
4. Ensure that 2 - "D" size batteries have been installed.
5. Open the grill lid.

	⚠ WARNING	
	Explosion Risk Fire Risk	
Failure to open the grill lid during the lighting procedures could result in a fire or explosion which could cause property damage, serious bodily injury or death.		

6. Set control knob to OFF and open the LPG cylinder valve.
7. Push and turn ignitor control knob to HIGH. The built-in

ignitor will click and spark to ignite burner. Ignitor may need realignment to generate adequate spark.



8. Confirm ignition by viewing flame through the convection plate holes.
9. If the burner does not light, turn the control knob to OFF, wait 5 minutes for gas to clear, then retry.
10. Adjust control knob to the desired cooking temperature.

	⚠ WARNING	
	Explosion Risk Fire Risk	
IF YOU SMELL GAS:		
<ul style="list-style-type: none">• Shut off gas supply to the grill.• Extinguish any open flame.• Open grill lid.• If odor continues, immediately call your gas company or local fire department.		
Failure to comply with these instructions could result in a fire or explosion which could cause property damage, serious bodily injury or death.		

Checking For LP Gas Leaks

Never test for leaks with a flame. Check for gas leaks prior to first use, at the beginning of each season, or every time the LPG cylinder is changed. Follow these four steps:

1. Use a commercially-available non-corrosive leak check solution.
2. Turn the grill control knob to the full OFF position, then turn the gas ON at source.
3. Apply the leak check solution to all gas connections. Bubbles will appear in the leak check solution if the connections are not properly sealed. Tighten or repair as necessary.
4. If there is a gas leak that cannot be repaired, turn off the gas at the source, disconnect fuel line from the grill and call the gas grill dealer, or gas supplier for repair assistance.

	⚠ WARNING	
	Fire Risk Explosion Risk	
A strong gas smell, or the hissing sound of gas indicates a serious problem with the gas grill or the LPG cylinder.		
<ul style="list-style-type: none">• Get away from the LPG cylinder.• Do not try to fix the problem yourself.• Call the fire department. (Do not call near the LPG cylinder because the telephone is an electrical device.)		
Failure to immediately follow the steps listed above could result in a fire or explosion which could cause property damage, serious bodily injury or death.		

Lighting the Grill by Match

To light the gas grill by match, follow steps 1 through 6 of the Basic Lighting Procedures. Then, insert a lit match through the lighting hole on either side of the grill (see Figure 2). Turn the nearest control knob to the HIGH setting to release gas. The burner should light immediately.

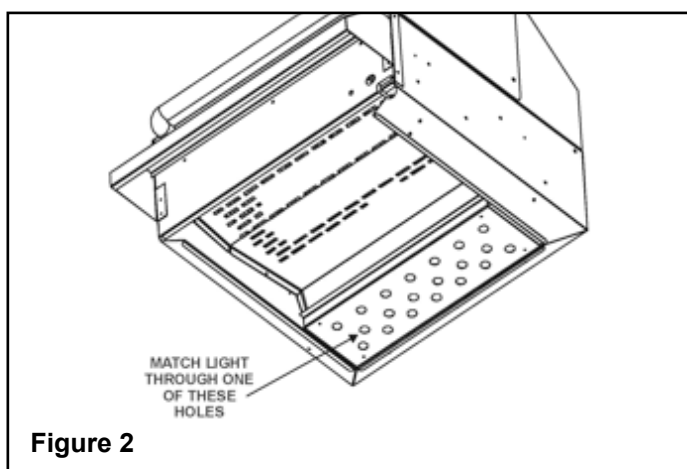

	⚠ WARNING
	Hot Surfaces
<ul style="list-style-type: none">• Never lean over the grill cooking area while lighting the gas grill.• Keep face and body a safe distance (at least 18 inches) from the lighting hole or burners, when lighting the grill by match.	

If the grill fails to light properly:

1. Turn gas off at source and turn the control knob to OFF. Wait at least five minutes for gas to clear, then retry.
2. Check gas supply and connections.
3. Repeat lighting procedure. If the grill still fails to operate properly, turn the gas off at source, turn the control knob to OFF, then check the following:

- **Problem:** Obstruction in gas line

Correction: Remove fuel line from grill. Do not smoke! Open gas supply for one second to clear any obstruction from fuel line. Close off gas supply at source and reconnect fuel line to grill.

- **Problem:** Pugged orifice

Correction: Remove burner from grill by removing two screws using a screwdriver. Carefully lift burner up and away from gas valve orifice. Remove the orifice from gas valve and gently clear any obstruction with a fine wire. Then reinstall all orifices, burners, cotter pins and cooking components.

If an obstruction is suspected in gas valve, please call the gas grill dealer or gas appliance service person for assistance.

- **Problem:** Misalignment of ignitor on burner

Correction: Check for proper position of the electrode tip. The tip of the electrode should be pointing over burner ports at the top of the burner. The gap between the spark electrode and the burner should be 1/8 inch. Adjust if necessary. With the gas supply closed press and turn control knob counterclockwise and check for presence of spark.



- **Problem:** Disconnected Ignition Wires

Correction: Inspect the Ignitor junction box found beneath the Control Panel. Connect loose Ignitor wires to the junction box and try to light the grill.

- **Problem:** Weak batteries

Correction: Replace “D” size batteries on ignitor module underneath grill control panel.

4. If all checks or corrections have been made and the grill still fails to operate properly, call the gas grill dealer or gas appliance service person.

 WARNING		
	Explosion Risk Fire Risk	
If a “FLASH-BACK” fire occurs in or around the burner tubes:		
<ul style="list-style-type: none">• Immediately turn the gas OFF at its source.• Turn the control knobs to OFF position.• Once the grill has cooled down, clean the burner tubes and burners according to the cleaning instructions in this manual.		
Failure to comply with these instructions could result in a fire or explosion which could cause serious property damage, bodily injury or death.		

Cooking Instructions

Important: Before cooking on the grill for the first time, wash the cooking grids and sear plates with warm, soapy water. Rinse and dry thoroughly.

Place porcelain Cooking Grids on the ledge.

Burn-off

Before cooking on the gas grill for the first time, you will want to “burn off” the grill to eliminate any odor or foreign matter. Just ignite the burner, close the lid, and operate grill on the HIGH setting for about five minutes with burner full forward (convection) and full back (sear).

Preheating

To preheat, light the grill on HIGH, close the lid and follow this timetable:

- For both high and low temperature cooking, preheat grill 10 minutes.
- To slow cook, preheating is not necessary.

Cooking Temperatures

High setting: Use this setting for fast warm-up, searing steaks or chops and for burning food residue off the grill after cooking is complete.

NOTE: Temperature settings will vary with the amount of wind and temperature outside your home.

Searing Deck

Place at the rear of grill.

SS Cooking Grids

First insert the back of the cooking grids onto the surface in front of the searing deck and drop front into place.

Electronic Operation

- Step 1. Select the type of food being cooked.
- Step 2. Use the temperature control knob to select temperature. Set probe switch to “On” position (this will set the alarm).
- Step 3. Insert probe into meat and close lid. Each light will turn red once that temperature is reached, and an alarm will sound once the desired temperature is achieved.

Burner

Slide burner front to back verifying burner operation. Burner should slide freely.

Sear Cooking - Burner in rear position

Convection Cooking - Burner in front position

Flare-Ups

The fats and juices dripping from grilled food can cause flare-ups. Since flare-ups impart a favorably distinctive taste and color to food cooked over an open flame, they should be accepted up to a point. Nevertheless, uncontrolled flaring can result in a ruined meal.

WARNING



**HOT! DO NOT TOUCH.
SEVERE BURNS MAY RESULT.
CLOTHING IGNITION MAY RESULT.**



Surfaces are hot during operation and cool down.

- Keep children away. CAREFULLY SUPERVISE children in same area as grill.
- Alert children and adults to hazards of high temperatures.
- Never lean over the cooking area while grill is on.

Cleaning and Maintenance Instructions

As with all appliances, proper care and maintenance will keep this grill in top operating condition and prolong its life. By following these cleaning procedures on a timely basis, the grill will stay clean and work properly with minimum effort.

Cleaning The Cooking Surfaces

Before initial use and periodically, wash the cooking grids in a soap and warm water solution. Use a wash cloth or vegetable brush to clean the cooking grids.

CAUTION: Never try to clean the cooking grids until they are cool to the touch.

Cleaning The Grease Tray and Receptacle

To reduce the chance of fire, the Grease Draining Tray and Grease Receptacle should be visually inspected before each grill use. Remove any grease and wash grease tray with a mild soap and warm water solution.

Cleaning The Burner Tubes and Burner Ports



NOTE: It is not necessary to remove the burner when cleaning the burner tubes and ports.

To reduce the chance of "FLASH-BACK" follow the procedure below at least once a month in late summer or early fall when spiders are most active or when the grill has not been used for a period of time.

1. Turn all burner valves to the full OFF position.
2. Turn the LPG cylinder valve (clockwise) to the full OFF position.
3. Detach the regulator assembly from the LPG cylinder by turning the Quick Coupling Nut counterclockwise.
4. Remove the cooking grids and searing plates.
5. Remove grease tray.

Regardless of which burner cleaning procedure is used, we recommend you also complete the following steps to help prolong burner life.

1. Clean rear burner ports from area below searing plate.
2. Clean front burner ports from area underneath by removing grease tray.
3. Use a wire brush to clean the entire outer surface of burner until free of food residue and dirt.
4. Clean any clogged ports with a stiff wire, such as an open paper clip.
5. Inspect burner for damage (cracks or holes) and if such damage is found, order and install a new burner. After installation, check to insure that the gas valve orifices are correctly placed inside the ends of the burner tubes. Also check the position of the spark electrode.

	! WARNING	
	Explosion Risk Fire Risk	
	<ul style="list-style-type: none">• Check to ensure the orifice is inside the burner tube before using the gas grill.• If the burner tube does not fit over the valve orifice, lighting the burner may cause explosion and/or fire.	

Keep surface of even heat convection plate clean

1. Remove cooking grids.
2. Use a putty knife to scrape area clean.
3. Make sure perforations are free of any obstructions.

Checking Burner Flame Patterns

For proper operation the burner flame characteristics should be steady, not lifting or floating (see Figure 3).

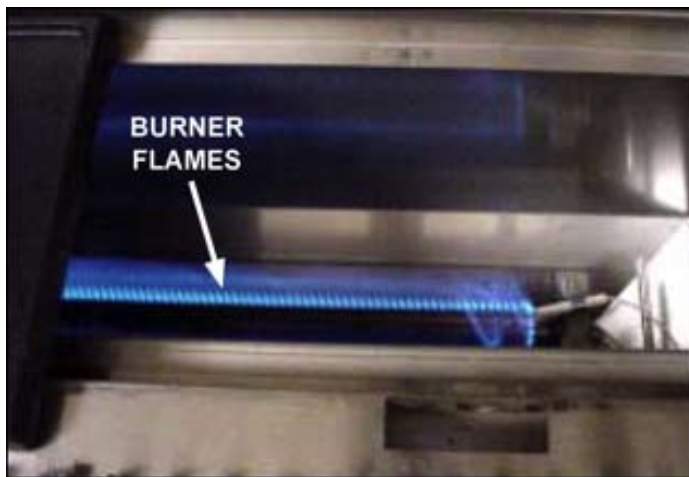

Figure 3



CAUTION: Be sure the grill is OFF and cool before cleaning.

Annual Cleaning of The Grill Interior

Burning-off the grill after every cookout will keep it ready for instant use. However, once a year you should give the entire grill a thorough cleaning to keep it in top operating condition.

Follow these steps:

1. Turn all burner valves to the full OFF position.
2. Turn the LPG cylinder valve (clockwise) to the full OFF position.
3. Detach the regulator assembly from the LPG cylinder by turning the Quick Coupling Nut counterclockwise.
4. Cover gas valve orifice with aluminum foil.
5. Brush the inside and bottom of the grill with a stiff wire brush, and wash with a mild soap and warm water solution. Rinse thoroughly and let dry.
6. Remove aluminum foil from orifices and check orifice for obstruction.
7. Check spark electrode, adjusting as needed. The Electrode tip should be pointing toward the burner ports approximately 1/8" from the burner surface.
8. Reconnect the gas source and observe the burner flame for correct operation.

	WARNING	
	Fire Risk Explosion Risk	
Do not line the bottom of the grill housing with aluminum foil, sand or any substance that will restrict the flow of grease into the grease draining tray and receptacle.		
• Failure to comply with these instructions could result in a fire or explosion which could cause property damage, serious bodily injury or death.		

Cleaning Exterior Surfaces

Before initial use, and periodically thereafter, wash the grill using a mild soap and warm water solution. Use a wash cloth or sponge for this process. Do not use a stiff wire or brass brush that might remove paint during the cleaning process.

Cleaning Exterior Stainless Steel Surfaces

Weathering and extreme heat can cause exterior stainless steel surfaces to turn tan in color. Follow these steps for the best cleaning results.

1. Turn the LPG cylinder valve (clockwise) to the full OFF position. Disconnect the regulator and hose assembly from LPG cylinder. Cover exposed gas fitting with aluminum foil.
2. Remove dirt or grease using a soft cloth and polish stainless surfaces using a Stainless Steel Foam Cleaner. Never use abrasive cleaners or scrubbers—they will scratch and damage the stainless steel.
3. Wipe with a soft cloth and allow to air dry before starting the grill.

Contact Information



Fire Stone Home Products
12400 Portland Ave. So.
Burnsville, Mn 55337
www.firestonehp.com

Please contact your Fire Stone Home Products dealer with any questions or concerns. For the number of your nearest Fire Stone Home Products dealer, please call 952-358-7410.

- NOTES -

CAUTION



Do NOT discard this manual.



- Important operating and maintenance instructions included.
- Read, understand and follow these instructions for safe installation and operation.
- Leave this manual with party responsible for use and operation.

Printed in Taiwan Copyright 2007

This product is covered by one or more of the following patents: (United States) 4,112,913; 4,408,594; 4,422,426; 4,424,792; 4,520,791; 4,793,322; 4,852,548; 4,875,464; 5,000,162; 5,016,609; 5,076,254; 5,191,877; 5,218,953; 5,328,356; 5,429,495; 5,452,708; 5,542,407; 5,613,487; (Australia) 543790; 586383; (Canada) 1,123,296; 1,297,746; 2,195,264; (Mexico) 97-0457; (New Zealand) 200265; or other U.S. and foreign patents pending.